

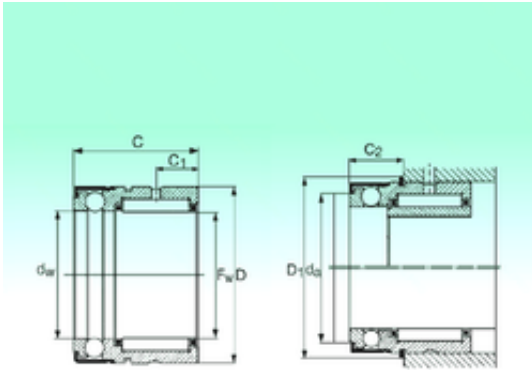

FML ske Manufacturing Co., Ltd



NX 25 Z Bearing 2D drawings and 3D CAD models

NBS NX 25 Z complex bearings

Bearing No. NX 25 Z

Size	25x37x30 mm
Bore Diameter	25 mm
Outer Diameter	37 mm
Width	30 mm
d	25 mm
Fw	0,115 mm
D	37 mm
C	30 mm
C1	8 mm
D1	40,4 mm
C2	14,2 mm
da	31,6 mm
Dynamic load rating radial (C)	14 kN
Dynamic load rating axial (C)	11 kN
Static load rating radial (C0)	21 kN
Static load rating axial (C0)	24 kN