

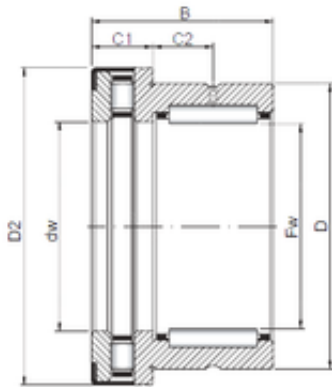

FML ske Manufacturing Co., Ltd

17 mm x 26 mm x 25 mm ISO NKXR 17 Z complex bearings



Bearing No. NKXR 17 Z

Size	17x26x25 mm
Bore Diameter	17 mm
Outer Diameter	26 mm
Width	25 mm
d	17 mm
Fw	17 mm
D	26 mm
B	25 mm
C1	9 mm
D2	31,2 mm
C2	8 mm

NKXR 17 Z Bearing 2D drawings and 3D CAD models